











## 16.5 ALU

	16,50 m		14,50 m		7,80 m (200 kg) 10,50 m (80 kg)
	200 kg		1,40x0,70x1,10 m		60°+60°
	360°		DS Stabilizzatori a discesa in sagoma Stabilisateurs dans le gabarit Straight line stabilizers Stützen innerhalb der Fahrzeugbreite		3,5 t

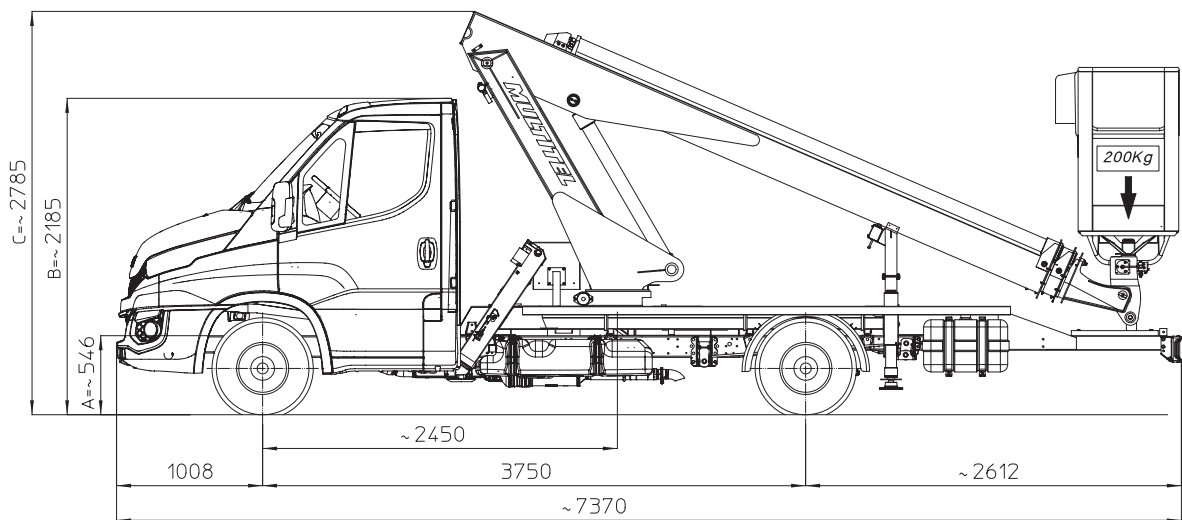
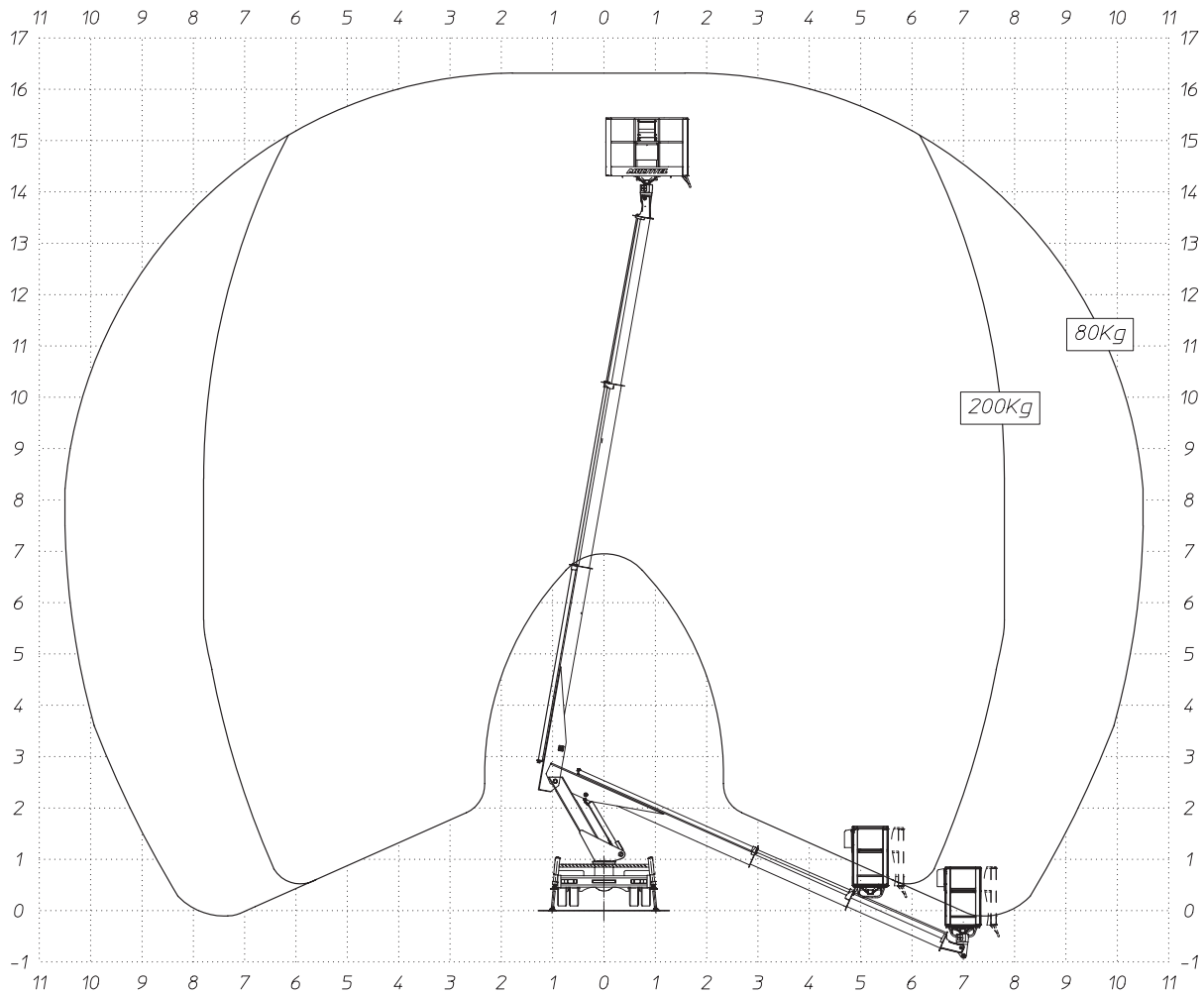

#### MULTITEL PAGLIERO S.P.A.

Strada Statale, 114  
12030 MANTA (CN) - ITALY  
Tel. +39 0175 255211 - Fax +39 0175 255255  
info@pagliero.com

#### Filiali

Corso Piemonte, 54  
10099 S.MAURO T.S.E (TO) - ITALY  
Tel. +39 011 2236792 - Fax +39 011 2236761

Via dell'Offelera, 106  
20861 BRUGHERIO (MB) - ITALY  
Tel. +39 039 883393/4 - Fax +39 039 2872140

#### MULTITEL INTERNATIONAL SAS

87, rue du Morellon  
38070 ST. QUENTIN FALLAVIER - FRANCE  
Tel. +33 (0)4 74 94 63 19 - Fax +33 (0)4 74 94 46 97  
info@multitelinternational.com

#### MULTITEL EXPORT SALES GmbH

Carl-Zeiss-Straße, 34  
52477 ALSDORF - DEUTSCHLAND  
Tel. +49 (0) 2404 675 580 - Fax +49 (0) 2404 675 58 29  
export@pagliero.com

#### MULTITEL UK Ltd

c/o Simmons Gainsford  
7/10 Chandos Street, Cavendish Square - London W1G 9DQ  
info.uk@pagliero.com

